

SIRIO MT 64 ÷ 800KW

CENTRAL INVERTER

SIRIO 





User manual

RPS SpA
via Somalia, 20
20032 Cormano (MI)
www.riello-solartech.it

No reproduction of any part of this manual, even partial, is permitted without the manufacturer's authorization. The manufacturer reserves the right to modify the product described herein, in order to improve it, at any time and without notice.

Symbols used in the manual

In this manual, some operations are highlighted by graphic symbols to alert the reader to the dangerous nature of the operations:

	DANGER	This symbol indicates the possibility of serious injury to the person and / or substantial damage to the unit if the indicated instructions are not followed
	WARNING	This symbol indicates an important piece of information that must be read and followed carefully.
	READING	This symbol indicates an important piece of information and/or procedures that are recommended to be read carefully.







Protective equipment to be worn

No maintenance operations must be carried out on the device without wearing the Personal Protective Equipment (PPE) described below

Personnel involved in the installation or maintenance of the equipment must not wear clothes with wide sleeves or laces, belts, bracelets or other items that may be dangerous, especially if they are metallic.

Long hairs must be tied in such a way as to ensure that they are not a hazard.

The following symbols show the protective equipment that should be worn. The various items of PPE must be selected and sized according to the nature of the hazard (particularly electrical) posed by the equipment.

	Protective footwear Use: always		Protective eyewear Use: always
	Protective clothing Use: always		Helmet Use: when overhead structured are present
	Work gloves Use: always		



Definition of “operator” and “specialised technician”

The professional figure responsible for accessing the equipment for ordinary maintenance purposes is defined by the term **operator**.

This definition covers personnel that know the operating and maintenance procedures for the equipment, and that have been:

1. trained to operate in accordance with the safety standards relating to the dangers that may arise where electrical voltage is present;
2. trained to use Personal Protective Equipment and to carry out basic first aid.

The professional figure responsible for the installation and start-up of the equipment, and for any extraordinary maintenance, is defined by the term **specialised technician**.

This definition covers personnel that, in addition to the requirements listed above for a general operator, must also:

1. have been suitably trained by the manufacturers or their representatives.
2. be aware of installation, assembly, repair and service procedures, and have a specific technical qualification.
3. have a background of technical training, or specific training relating to the procedures for the safe use and maintenance of the equipment.



Emergency Interventions

The following information is of a general nature.



First aid interventions

Company regulations and traditional procedures should be followed for any first aid intervention that may be required.



Firefighting measures

Do not use water in case of fire, but only fire extinguishers that are suitable for use with electrical and electronic equipment.

If exposed to heat or fire, some products may release toxic fumes into the atmosphere. Always use a respirator when extinguishing a fire.



General Precautions

This manual contains detailed instructions for the use, installation and start-up of “NXE”.

Read the manual carefully before installation. The manual should be kept at hand and be consulted before carrying out any operation on the device.

With the Unit, along with this manual, it is also supplied with:

- The “**Safety and Compliance Manual**”.
- The installation manual “**Installation drawings**” providing useful information for connecting and installing the equipment.
- The “**Display Manual**” containing all of the information for monitoring the unit and for managing the display-programmable functions.

Read the manuals carefully before installation and commissioning.

This device has been designed and manufactured in accordance with the standards for the product, for normal use and for all uses that may reasonably be expected. It may under no circumstances be used for any purposes other than those expected, or in any other ways than those described in this manual. Any interventions should be carried out in accordance with the criteria and the time-frames described in this manual.



Safety Precautions

CAUTION: Dangerous voltage can also be present inside the equipment even with the input, bypass, output and battery switches open.

Removing the UPS enclosure by unauthorised personnel is a source of danger and may cause serious injuries to the operator.

Read the “**Safety and Compliance Manual**”.



Environmental Protection





In the development of its products, the company allocates abundant resources to analyse the environmental issues.

All our products pursue the objectives defined in the environmental management system developed by the company in compliance with applicable standards.

No hazardous materials such as CFCs, HCFCs or asbestos are used in this product.

When evaluating packaging, the choice of recyclable materials has been preferred.

For correct disposal, please separate and identify the type of material of which the packaging is made in the table below. Dispose of all material in compliance with applicable standards in the country in which the product is used

<i>DESCRIPTION</i>	<i>ELEMENT</i>	
Pallet	Wood (FOR)	
Package box	Corrugated cardboard (PAP)	
Protective bag	High density polyethylene (PE-HD)	
Bubble wrap	Low density polyethylene (PE-LD)	



Disposing of the product

The UPS contains electronic cards and batteries which are considered TOXIC and HAZARDOUS waste. When the product reaches the end of its operating life, please dispose of it in accordance with applicable local legislation.

Disposing of the product correctly contributes to respecting the environment and personal health.

Thank you for choosing our product.

RIELLO Solar Tech. is highly specialized in the development and production of equipment for static energy conversion. The inverters of the three-phase SIRIO series are high quality products, carefully designed and manufactured to ensure optimum performance.



GENERAL PRECAUTIONS

This manual contains instructions for the use, installation and start-up of SIRIO inverters. Read the manual carefully before installation. The manual should be kept close at hand and consulted for information on using the equipment before carrying out any operation.

- *The first connection to be made is the connection between the earth conductor and the terminal with the symbol shown here:* 
- *The inverter must not operate without an earth connection.*
- *The equipment must be installed and used in accordance with the instructions contained in this document and in the manner suggested from time to time. RIELLO Solar Tech. is not liable for defects or malfunctions resulting from improper use of the equipment, alterations due to transport or particular environmental conditions, failure or improper servicing, tampering or temporary repairs, and the use or installation by unqualified individuals.*
- *If the inverter is not used according to the manufacturer's specifications, the security provided by the inverter could get lost.*
- *The operating and maintenance personnel and specialized technicians should be adequately trained in the safe use and maintenance of the device. They should always operate with due precaution and wear personal protective equipment (PPE).*
- *Maintenance must not be carried out inside the inverter when it is being powered from the mains or the DC voltage. For maintenance switch the inverter off and open all the other switches. Always use a multimeter to ensure that there are no dangerous voltages.*
- *There are dangerous voltages inside the equipment even when the input and output switches are in the open position; trained personnel must wait around 20 minutes for the capacitors to discharge before working on the inside of the inverter.*
- *The specialized technician must comply scrupulously with the following instructions for the installation and maintenance of the inverter:*
 - *use insulated tools.*
 - *observe polarities.*
 - *if the fuses need replacing, replace only with the same type.*
 - *the replaced components must be disposed of in accordance with the legislation in force in the country of installation.*
- *Do not deactivate the protection devices or ignore the warnings, precautions and alarms described in this manual or those shown on data plates on the equipment.*
- *Promptly replace any danger signals if they should become illegible through usage.*
- *The inverter must be used only with all side and internal panels duly secured and with the front door closed.*
- *Under no circumstances may the structure of the equipment, the devices mounted on it, the operating sequence, etc. be modified, tampered with or altered in any way without first consulting the manufacturers.*
- *All ordinary and extraordinary maintenance operations must be noted in the appropriate register with the date, time, type of intervention, operator name and any other useful information.*

- *Once the maintenance operations have been concluded, a thorough check should be made in order to ensure that no tools and/or other materials have been left inside the cabinet.*
- *In the event of faults or malfunctions, contact your local distributor or RIELLO Solar Tech. All repair operations must be carried out by authorized technicians.*
- *Under no circumstances must water be used to clean the internal or external electrical parts of the cabinet.*
- *Do not leave the device exposed to rain or to the elements. The device must be stored and used in premises that comply with the environmental requirements set out in this user manual.*

Instructions for use



The purchased equipment is intended for professional use in industrial or commercial environments. Shielded cables must be used for the connections to signal connectors.

Warning



Sale of this product is reserved for competent installers. Installation restrictions or additional measures may be necessary in order to avoid problems.

CE Mark

The inverters of the SIRIO series come with CE marking; when used in accordance with the instructions in this manual, they comply with the requirements of the following directives:

- LV Directive 2006/95/EC.
- EMC Directive 2004/108/EC.

No reproduction of any part of this manual, even partial, is permitted without the manufacturer's authorization. The manufacturer reserves the right to modify the product described herein, in order to improve it, at any time and without notice.

Sommario

INTRODUCTION.....	9
STORAGE	10
INSTALLATION ENVIRONMENT	10
PRELIMINARY OPERATIONS.....	10
CHECKING THE PACKAGING.....	10
POSITIONING	11
ELECTRICAL SYSTEM SETTINGS.....	12
SYSTEM PROTECTION.....	12
PHOTOVOLTAIC FIELD / NETWORK CONNECTIONS.....	12
CONNECTORS FOR REMOTE COMMANDS, SIGNALLING AND COMMUNICATIONS.....	14
ETHERNET / USB.....	17
CHECK CONNECTIONS.....	17
START-UP PROCEDURE.....	18
FUNCTIONAL CHECK.....	19
SHUTDOWN.....	19
PERSONALIZATIONS	19
OPERATION	20
MAINTENANCE	21
GENERAL CHARACTERISTICS	22
INVERTER USER PANEL FUNCTIONS.	26
GENERAL DESCRIPTION.	26
ALARM MESSAGES	27
CONTROL PANEL	29

INTRODUCTION

This document describes the features of the Three-phase Solar Converters of the SIRIO series without isolation transformer dedicated to medium voltage connection.

The SIRIO inverter is used to transfer the energy produced by a photovoltaic generator to the three-phase power distribution system. The MPPT (Maximum Power Point Tracking) feature ensures that the power is drawn from the photovoltaic modules with the operating point continuously optimized in relation to the irradiation conditions, the characteristics of the panels, their temperature and the converter characteristics.

The system is designed to allow it to feed into the network a current with a sinusoidal waveform and uniform power factor in all operating conditions.

The operating parameters and electrical values can be displayed locally, by means of the alphanumeric LCD display.

The functions listed above are obtained by means of power electronic architecture of the PWM (Pulse Width Modulation) type using semiconductors of the IGBT (Insulated Gate Bipolar Transistor) type and a microprocessor-based control logic which can carry out all the required processing in real time.

As example the figure below shows the K500 HV MT inverter block diagram:

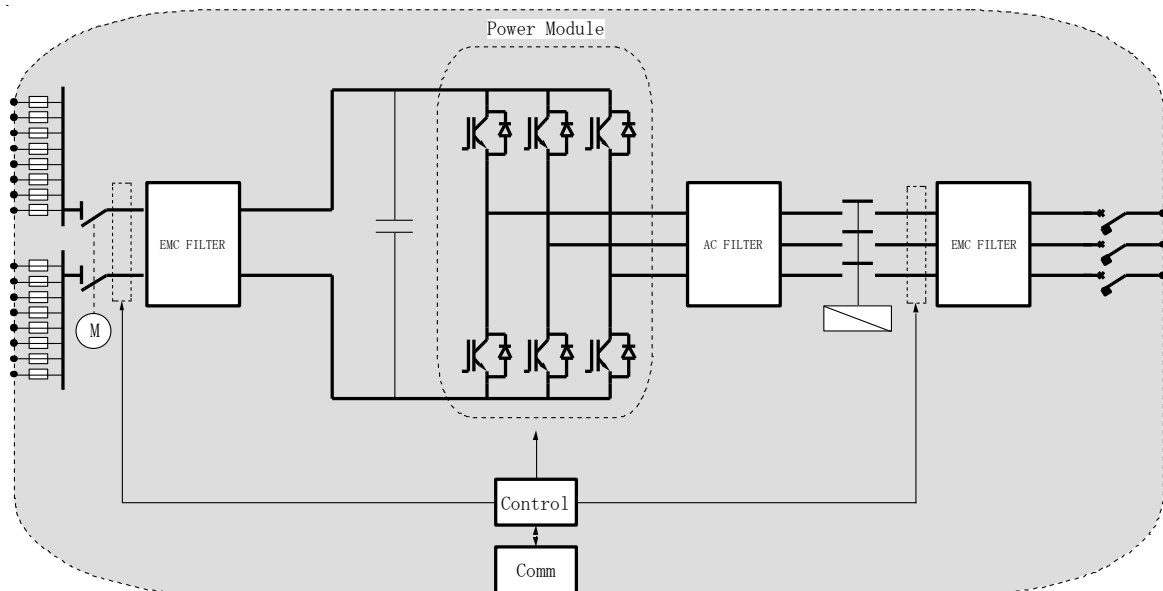

- EMC filters: these are used to reduce conducted radiofrequency emissions on both the photovoltaic modules and on the AC network
- Power Module: this is the section in which the energy from the photovoltaic modules is converted from direct current into alternating current.
- AC filter: its function is to recreate a sinusoidal current waveform by eliminating the high frequencies generated by the inverter stage.
- Contactor: separates the inverter from the AC network during periods of non-operation.
- DC disconnecter: disconnects the photovoltaic field from the inverter to allow maintenance to be carried out on the inverter. K330 and K500 models use an automatic DC disconnecter with motor.
- AC disconnect switch: disconnects the inverter from the AC network in the event of maintenance and is triggered to protect the network in the event of an internal fault in the AC section of the device
- Control system: this is the heart of the entire system that manages all parts of the equipment.
- Communications: for local monitoring (LCD display with touch screen) of inverter operation or remote monitoring by means of appropriate electrical connections.

STORAGE

If the inverter is not installed immediately, it should be stored with its original packaging and protected from humidity and the elements. The storage premises should comply with the following characteristics:

Temperature:	-25°C ÷ + 60°C (-13°F ÷ 140°F)
Relative humidity	5 - 95%

Recommended storage temperature is between +5°C and +40°C.

INSTALLATION ENVIRONMENT

The equipment has been designed for indoor installation. The choice of premises for installation should comply with the points set out below:

- avoid dusty environments;
- ensure that the floor can support the weight of the inverter;
- avoid narrow environments that could hinder normal maintenance operations;
- avoid placing the device in areas exposed to direct sunlight or heat;
- ensure that the ambient temperature, with inverter operating, is less than:

<i>operating temperature:</i>	-20 ÷ +50°C
<i>maximum temperature for 8 hours a day:</i>	+ 45°C
<i>average temperature for 24 hours:</i>	+ 35°C
<i>Relative humidity</i>	5 -95%

N.B.: the operating temperature recommended for the lifetime of the inverter is between 10°C and 35°C. A heat dissipation system is required to keep the temperature in the installation site within this field (the value of the power dissipated by the inverter is shown in the section "GENERAL CHARACTERISTICS").

PRELIMINARY OPERATIONS

Checking the packaging

- Upon receipt of the inverter, check that the packaging has not been damaged during shipping.
- Check that neither of the two impact resistant devices on the packaging has turned red; if one of them should be red, follow the instructions on the packaging.
- Care should be taken when removing the packaging in order to avoid scratching the inverter cabinet.
- The device must be handled with care; it may be damaged if knocked or dropped.
- This technical user manual is supplied with the inverter.

The device should only be handled by appropriately trained personnel. It can be unloaded from the vehicle and put into place by lifting the box or the wooden deck to which the equipment is secured with a fork-lift truck. A trans pallet or fork-lift truck should be used for the permanent positioning of the equipment, in accordance with the instructions provided below.

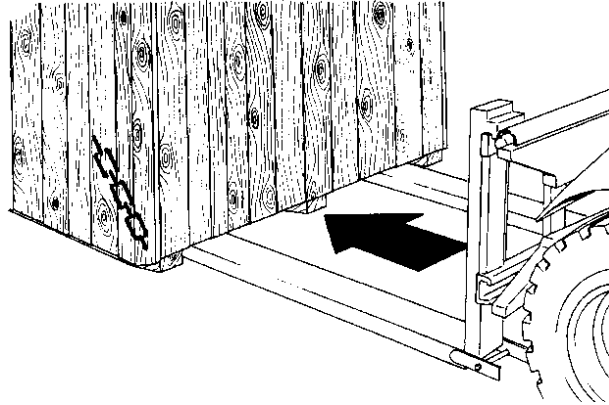

- (1) Insert the forks of the fork-lift truck in the lower part of the device, from the front or back, and ensure that they stick out about 30 cm on the other side. If a trans pallet is used, raise the device only as much as is strictly necessary.
- (2) Secure the device to the trans pallet or fork-lift before moving it.

Risk of overturning



In order to avoid the risk of the device overturning, ensure that it is firmly secured to the trans pallet or fork-lift truck by means of appropriate ropes before moving it.

The cabinet should be handled with care during these operations, since knocks or drops can damage it. Once in position, remove the packaging carefully so as not to scratch the device. The packaging should be removed as follows:

- Cut the bands
- Carefully remove the cardboard packaging from above.
- Remove the screws securing the cabinet to the wooden base.
- If using a trans pallet, remove the device from the pallet and place it on the floor, using the same precautions as set out in the section on Handling.

POSITIONING

Cooling air enters the inverter from underneath and through the grilles located on the front of the door and exits through the ventilation grilles which are either at the top of the device or at the back, depending on the size of the equipment.

The following points should be taken into account when positioning the inverter:

- leave a free space of at least one meter at the front of the equipment to allow for maintenance operations.
- ensure a distance of at least 60 centimeters from the ceiling so as not to hinder air extraction.
- The DC and AC cables should enter from the back of the cabinet. The power and signal cables should be connected from the front.

Refer to the installation drawings for the mechanical dimensions of the inverter.

The drawings identify:

- the position of the holes in the base for the possible fixing of the equipment to the floor;
- the view of the support on the floor for the sizing of a possible structure to raise the cabinet;
- position of the cable entry;
- the position of the inverter fans.

ELECTRICAL SYSTEM SETTINGS

System protection

Ground



The minimum size of the ground conductor is equal to the greater of:

- Half of the total cross-section of the conductors of a phase of the AC section
- Half of the total cross-section of a cable polarity DC

AC output

An automatic magneto-thermal switch is provided on the inverter AC output line. Since this switch cannot protect the line connected to the inverter from any faults on the line, an appropriate protection device, sized according to the table above and to the characteristics of the cable that has been laid, is provided upstream of this switch.

IMPORTANT NOTES:

- The common mode output voltage has high frequency peak values up to $\pm 1100V$ respect to ground, then choose appropriate cables for connecting the AC line.
- In order to reduce noise to surrounding equipment, we recommend the use of shielded cables and a maximum length of 15 meters.

DC input

A disconnecter with an appropriately sized fuse is provided on the DC input line.

OPTIONAL: K330 and K500 models are available with 6 and 8 fused input with gPV 160A fuses for both plus and minus polarity.

Photovoltaic field / network connections



The operations described in this chapter must be carried out exclusively by trained personnel. The first connection to be made is the earth conductor, which is indicated with the symbol:





THE INVERTER MUST NOT OPERATE WITHOUT AN EARTH CONNECTION.

Before making the connection, open all the switches on the device and ensure that the inverter and the lines to be connected are completely isolated from the power sources (photovoltaic field and AC power line).

More specifically, check that:

- the line from the photovoltaic field is isolated from the field;
- the inverter disconnectors SWIN and SWOUT are in the open position;
- the DC switch Key lock is activated (K330 and K500 models)
- there are no dangerous voltages (DC and AC), by using a multimeter on both the cables and the inverter terminals

The inverter must be connected to a three-phase AC network (no neutral conductor is required) ungrounded (IT system)



Each inverter requires a separate LV / MV transformer or at least a dedicated winding. It is not allowed to parallel inverters. The LV winding of the transformer is not to be earthed.

WARNING: observe the cyclical direction of the phases.

Connectors for remote commands, signalling and communications

Open the front door of the inverter to access the interface cards:

Communications card (RS232 + EPO + REMOTE CONTACTS)

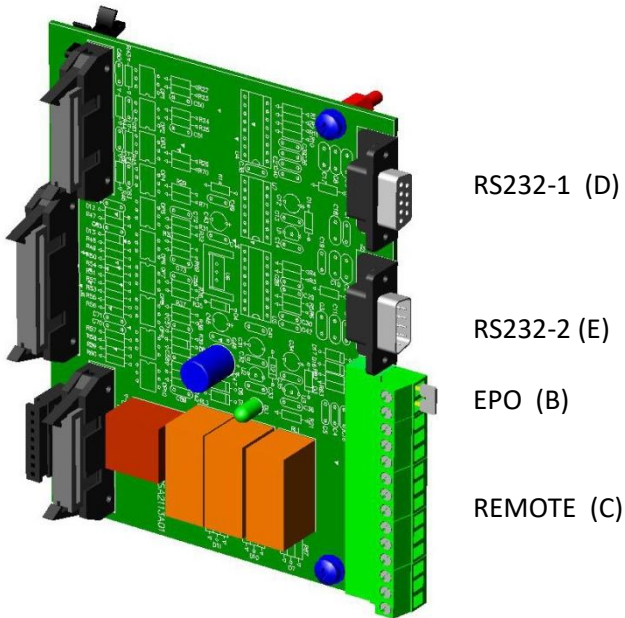

B - EPO connector (emergency power off command)

If jumper B on the connector is opened, the inverter will shut down and disconnect from the distribution grid. The inverter is factory-fitted with the EPO terminals short-circuited. With this input, in a hazardous situation the inverter can be shut down from a remote position simply by pressing a button.

Warning: normal operation cannot be restored simply by closing the jumper. This requires an operator to take appropriate action on the inverter control panel.



In K64, K80 and K100 the EPO command disconnects the inverter from the network, but does not open the connection with the photovoltaic field. Dangerous voltages may still be present in the device.

C - REMOTE

The connector comprises the following features:

- 1 12Vdc 80mA(max.) power supply
- 3 potential-free change-over contacts for alarms;
- 2 remote commands to block the inverter

- the connector has the following pin configuration:

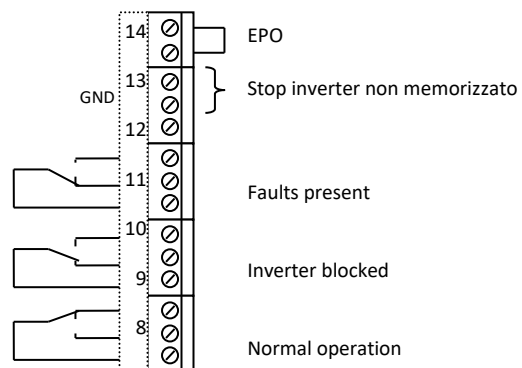

- **Normal operation:** the inverter is connected to and supplies energy to the network; it is normal for this signal not to be displayed, even when there are no faults or blocks, during poor irradiation conditions (night-time) or if the AC network is not adequate.

- **Inverter blocked** by command or contact: the inverter has been blocked by a command or by the triggering of a contact; specific action by the operator is required to restore operation

- **Faults present:** the inverter is blocked due to an internal failure

N.B. The position of the contacts as shown is with the condition present.

The contacts have a max. current flow of 0.5A at 42V.

REMOTE COMMANDS

Two commands are available:

- BLOCK INVERTER. Connect terminal 11 and terminal 12 to each other (for at least 2 seconds).(command not saved: when the contact is opened again, the inverter will resume normal operation).
- INVERTER EMERGENCY STOP (EPO). If the jumper between terminals 13 and 14 is opened, the inverter will block. (command saved: when the contact is opened again, the inverter will remain in a blocked state until the command is cancelled using the command display)

D-E RS232

2 DB9 connectors are available for RS232 connection.
The factory-set transmission protocol is the following:
9600 baud, -no parity, -8 bits, -1 stop bit.

See the diagrams below for the connection procedures.

D - DB9 female RS232-1

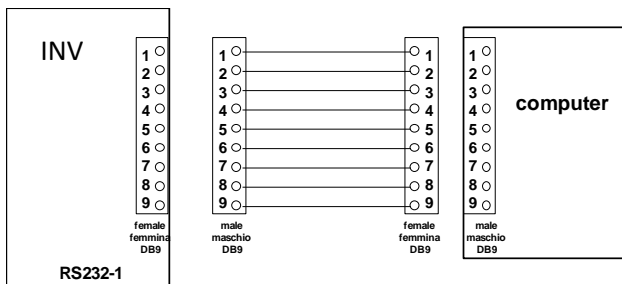

Use a standard cable for connection with a computer.

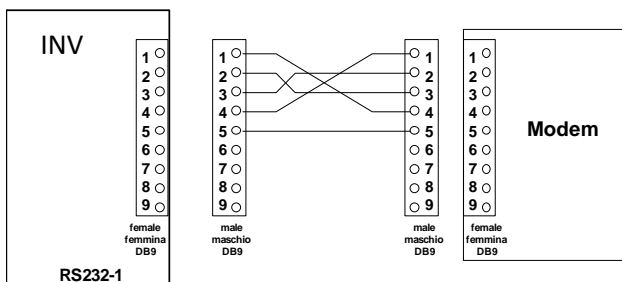

See the figure for connection with a modem.

E - DB9 male RS232-2

Use a standard cable for connection with a modem.

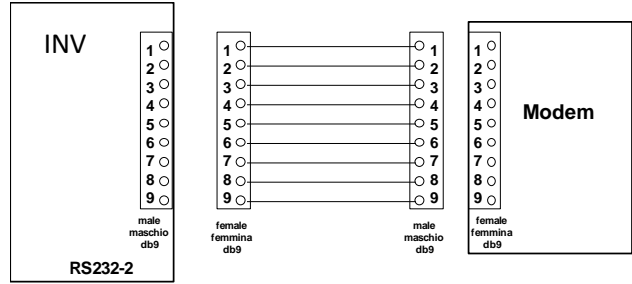

Use a null-modem cable for connection with a computer (see figure).

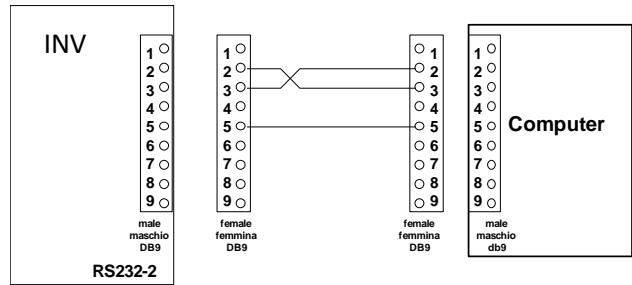

SLOTS 1-2 , the following cards may be inserted in these slots (optional):

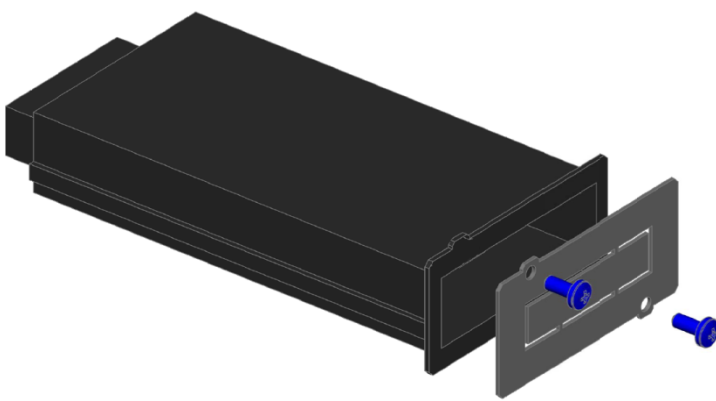

- **RS485 board:** provides an RS485 connection for connection of the inverter to remote devices.
- **Netman PV:** device for managing the inverter's Ethernet network, able to send information on the status of the machine with different protocols:
 - TCP / IP UDP (compatible with Sunvision software)
 - HTTP (to view the status with a browser);
 - FTP (for data transfer).

SYSTEM SLOT , housing in which to insert the optional RS485 card for connecting the PV Control Box accessory. See the manual of the accessory for additional information.

Note: the use of *SYSTEM SLOT* prevents the use of the RS232-1 and vice versa.

Ethernet / USB

A USB port and an Ethernet port are available on the Touch Screen for downloading historical data and monitoring of the inverter. Refer to the specific documentation for details on possible connections.

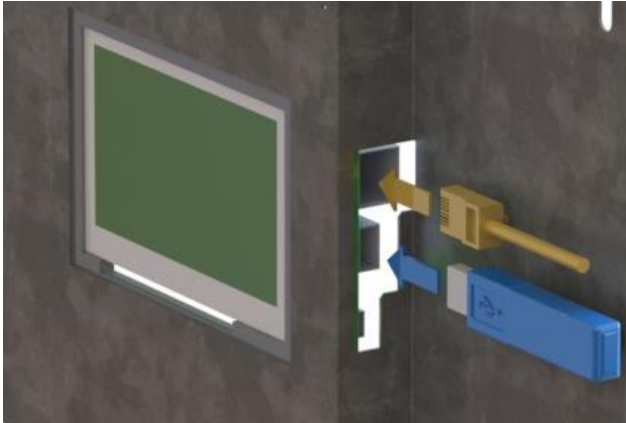

Check connections

Once the EARTH, INPUT and OUTPUT cables have been connected and before replacing the terminal board cover, check that:

- all the input/output terminals are tightly closed;
- all the fuse blocks have fuses inserted and are in the closed position;
- the protection conductor is correctly connected.

START-UP PROCEDURE

Once the electrical connections have been made as indicated above and after replacing the switch cover panel, the inverter can be started up; carry out the following operations in this order:

- open the door of the inverter to access the input switches;
- close any input/output switches located outside the inverter;
- check that the DC voltage from the photovoltaic field is within the inverter's accepted range; also check that the polarity is correct.
- For K64 – K250 inverters close the input and output inverter switches (the label is shown on the switches panel: SWIN DC side disconnecter, SWOUT network side switch)
- For K330 – K500 close SWOUT and remove the KEY lock of SWIN

At first start-up it is necessary to enter the country in which the inverter is installed so that the voltage and frequency protection settings are adjusted accordingly. Press the arrow keys until the country desired is displayed and then press on the "earth" to move to the next screen.

If the selection made is correct press the button with the checkmark to confirm the selection.

ATTENTION: the only way to change the selection made is to contact the RIELLO Solar Tech. technical assistance office.

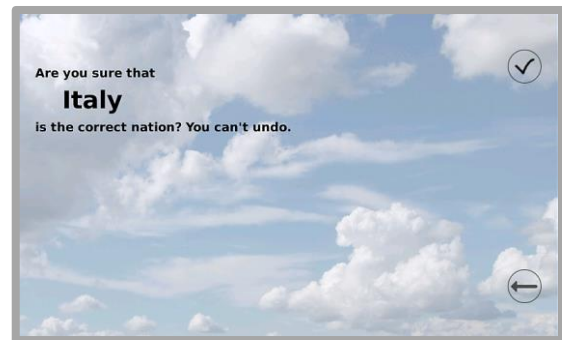



Once the above operations are complete, if the radiation conditions allow, the inverter will start up and connect to the grid after a pause (which lasts from about 10 seconds to 3 minutes depending on local regulations).

On the lower line of the panel the message NORMAL OPERATION should appear, while on the upper line the inverter model will appear.

N.B.: In the absence of AC power the inverter is not powered and the display remains off even when there is DC power coming from the photovoltaic modules. It is therefore necessary to supply power on the AC side in order to switch on the inverter.

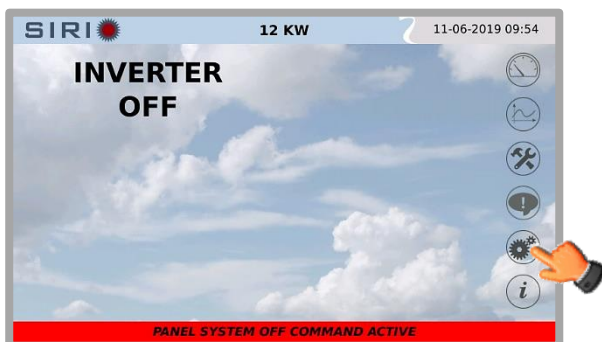
If the message "Inverter OFF" is displayed on the screen it means the inverter is "disabled". Therefore it must be enabled with the following key sequence:



Then press  to return to the main screen.

FUNCTIONAL CHECK

The correct operation of the inverter is shown on the LCD display by the normal operation message. During irregular irradiation conditions, the inverter may switch off and display the “low irradiation” message. Restart after an event of this kind is delayed, even when the DC voltage is sufficient, and the countdown time to restart is shown on the display. The countdown will not take place if the voltage is lower than the restart limit.

SHUTDOWN

This operation will cause the inverter to shut down and disconnect from the AC power grid.

Shutdown procedure:

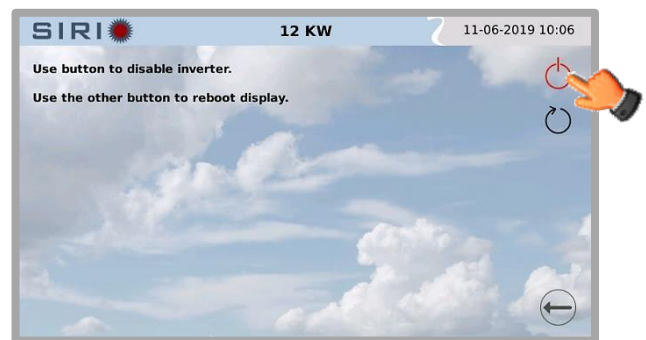
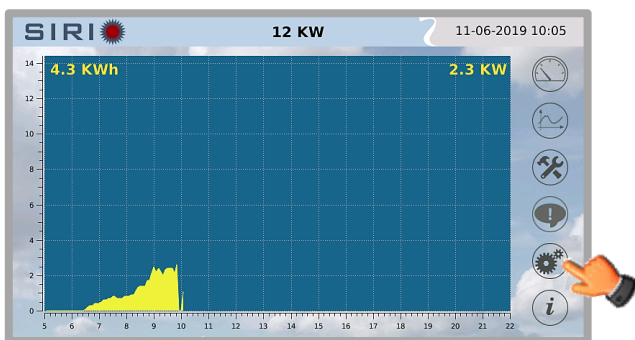

Press  to return to the main screen.

- open SWOUT, output switch;
- open SWIN, input switch and activate the Key lock if available.

Although no damage is caused to the inverter by opening the input and output disconnectors while the inverter is switched on, it is recommended to carry out the shutdown procedure before opening the disconnectors.

To restore normal inverter operation, perform the same operations carried out in the chapter start-up procedure

PERSONALIZATIONS

Refer to the documentation on the website www.riello-solartech.it the customizations that can be made from the control panel.

OPERATION

The operation of the inverter is fully automatic and does not need any user intervention. Once it has been connected to the photovoltaic generator and the three-phase distribution grid and has been enabled, the inverter will appropriately manage the start-up, shutdown and any other aspect of the equipment.

Once it has been enabled (which is saved even if there is no power supply), the inverter checks the parameters of the AC network (voltage and frequency) and of the photovoltaic modules (no-load voltage); if all the values are within the correct ranges for a suitable time (the count is shown on the display), the conversion process will start, preceded by the connection of the inverter to the network by closing the remote switch.

The MPPT algorithm integrated in the control system looks for the operating condition that is best suited to the external conditions (essentially irradiation and temperature of the modules).

When the irradiation conditions are such that the power injected into the network is very low (<1%), the control system shuts the inverter down after a few minutes and puts it into a wait state. This situation will last until the solar radiation is sufficient to allow a new start-up and connection to the network.

In order to avoid the converter operating "in island mode", some systems have been implemented which can destabilize a possible condition of balance between the inverter and local loads. In the event of electrical parameters going outside the permitted field, the inverter will activate protection devices and disconnect from the network until the rated conditions for the AC network are restored. If these protection devices are triggered, a pause is inserted before inverter operation can be resumed; the length of the pause depends on local legislation.

It should be noted that, for the Italian market, these protection devices cannot replace what are known as "interface protection devices" since current legislation imposes the presence of dedicated external protection devices when inverter power is greater than 20KW or when more than three inverters are connected at the same time.

The control system naturally also implements all the protection devices required to protect the converter from external faults. Suitable protection devices against overcurrents, overvoltages and overtemperatures inside the device are also used.

The inverter has a protection device to prevent stops due to overtemperature; when the temperature on the power transistor radiators exceeds a first alarm threshold, the maximum inverter power is gradually decreased from 110% to 100%. If a second alarm threshold is exceeded, the power is gradually decreased even more so as to keep the temperature of the heat sinks within the maximum limit. With an ambient temperature lower than 45°C and unobstructed heat sinks, the inverter can manage the rated power without limitations.

MAINTENANCE

SIRIO inverters are designed and produced to last a long time even in the most severe service conditions. It should be remembered however that this is electrical power equipment, which requires periodic monitoring. Moreover, some components have a limited lifespan and as such must be periodically checked and replaced should conditions so dictate: in particular the fans and in some cases the electrolytic condensers. It is therefore recommended to implement a preventive maintenance program, which should be entrusted to specialized personnel authorized by the manufacturers. Our Technical Support Service will be happy to recommend the various personalized options for preventive maintenance.

WARNING

Maintenance inside the inverter must only be carried out by trained personnel.



HIGH VOLTAGES are present inside the inverter even when the AC power supply and the photovoltaic modules have been disconnected.

After disconnecting the DC power line and the AC power grid, the trained personnel must wait for around twenty minutes for the capacitors to discharge before working on the inside of the equipment.

Preventive maintenance

The following operations should be carried out periodically:

Ensure that the air intake slots (located on the front door and at the back of the cabinet) and the output grilles located on the top of the cabinet are clean.

Ensure that the inverter is working properly (the message "NORMAL OPERATION" will appear on the display panel). If an alarm message is displayed, check the meaning in the manual before contacting the technical support service.

Check that the operating parameters are within the fields indicated in the section GENERAL CHARACTERISTICS.



Since the photovoltaic modules are a source of energy, just isolating the AC distribution system does not eliminate the danger. **PAY THE UTMOST ATTENTION TO THE DC VOLTAGE FROM THE PHOTOVOLTAIC MODULES EVEN IN CONDITIONS OF LOW SOLAR IRRADIATION.**

GENERAL CHARACTERISTICS

SIRIO HV MT				
Model		K64	K80	K100
Input				
Max PV power	Pmax	80 Kwp	100Kwp	125 Kwp
Minimum recommended PV power	Pmin	50 Kwp	64Kwp	80 Kwp
Recommended Vo@STC voltage	Vo	710-760 V		
DC voltage range, MPPT	Vcc	450-760 V		
Max DC voltage	Vcc,max	880 V		
Start-up voltage	Vstart-up	540 V		
Max DC current	Icc,max	157 A	196 A	245 A
Voltage ripple on modules		< 1 %		
DC inputs		1		
Output				
Rated AC power	Pca (p.f.=1)	64 KW	80KW	100 KW
Rated voltage	Vca	270 V trifase (+/-15%)		
Rated current	Ica	137 Aca	171 Aca	214 Aca
Max current	Ica	178 Aca	221 Aca	277 Aca
Rated frequency	Fca	50 Hz (+2 / -3 Hz)		
Distribution system		IT		
Harmonic distortion of the network current	THD%	< 3 % with rated power		
Nominal Power factor	cos ϕ	> 0.99 (adj. \pm 0.9)		
Contribution to short circuit current	Icc	267A	331A	415A
Standards				
Electromagnetic compatibility		YES		
CE conformity		YES		
Protection devices and environmental conditions				
IP protection degree EN60529		IP20		
Environmental categories		Indoor, unconditioned		
Overvoltage category (EN62109)		III (DC) – III (AC)		
Pollution degree		3		
Permitted temperature range	T	-20°C – 50°C ⁽¹⁾		
Maximum height above sea level		1000 m ASL ⁽²⁾		
Air change (with $\Delta T=5^{\circ}\text{C}$)		1020 m ³ / h	1020 m ³ / h	1020 m ³ / h
Direction of air flow		Intake through the base and the front Extraction from the top		
Max power dissipated (in overload)	P loss	1641 W 1402KCal/h	1641 W 1402KCal/h	1641 W 1402KCal/h
Mechanical				
Weight	Kg	380	400	420
Dimensions	mm	800x800x1900		

N.B.

(1) with ambient temperature over 45°C there will be a reduction of max power to the network

(2) over 1000m lower the power by 1% for every 100m up to a maximum of 3000m

SIRIO HV MT					
Model		K200	K250	K330	K500
Input					
Max PV power	Pmax	230 Kwp	290Kwp	380KWp	570KWp
Minimum recommended PV power	Pmin	160 Kwp	200Kwp	260KWp	400KWp
Recommended Vo@STC voltage	Vo	710-760 V			
DC voltage range, MPPT	Vcc	450-760 V			
Max DC voltage	Vcc,max	880 V		1000 V	
Start-up voltage	Vstart-up	540 V			
Max DC current	Icc,max	471 A	590A	780A	1180A
Voltage ripple on modules		< 1 %			
DC inputs (in parallel)		1		6x140A(opt)	8x140A(opt)
Output					
Rated AC power (p.f. = 1)	Pca	200 KW	250KW	330KW	500KW
Rated voltage	Vca	270 V trifase (+/-15%)			
Rated current	Ica	428 Aca	535 Aca	706A	1070A
Max current	Ica	475 Aca	630 Aca	830A	1260A
Rated frequency	Fca	50 Hz (+2 / -3 Hz)			
Distribution system		IT			
Harmonic distortion of the network current	THD%	< 3 % with rated power			
Power factor	cos ϕ	> 0.99 (adj. \pm 0.9)			
Contribution to short circuit current	Icc	831A	945A	1250A	1890A
Standards					
Electromagnetic compatibility		YES			
CE conformity		YES			
Protection devices and environmental conditions					
IP protection degree EN60529		IP20			
Environmental categories		Indoor, unconditioned			
Overvoltage category (EN62109)		III (DC) – III (AC)			
Pollution degree		3			
Permitted temperature range	T	-20°C – 50°C ⁽¹⁾			
Maximum height above sea level		1000 m s.l.m. ⁽²⁾			
Air change (with $\Delta T=5^{\circ}C$)	m ³ / h	3180	4750	6200	9500
Direction of air flow		Intake through the base and the front Extraction from the top			
Max power dissipated	W	5128	6410	8460	12820
	KCal/h	4381	5477	7230	10954
Mechanical					
Weight	Kg	1000	1050	1250	1320
Dimensions	mm	1600x1000x1900		1500x1000x1900	

N.B.

(1) with ambient temperature over 45°C there will be a reduction of max power to the grid

(2) over 1000m lower the power by 1% for every 100m up to a maximum of 3000m

SIRIO HHV MT			
Model		K330	K500
Input			
Max PV power	Pmax	380KWp	570KWp
Minimum recommended PV power	Pmin	260KWp	400KWp
Recommended Vo@STC voltage	Vo	780-880 V	
DC voltage range, MPPT	Vcc	530-820 V	
Max DC voltage	Vcc,max	1000 V	
Start-up voltage	Vstart-up	600 V	
Max DC current	Icc,max	660	1000
Voltage ripple on modules		< 1 %	
DC inputs		6x140A(OPT)	
Output			
Rated AC power (p.f. = 1)	Pca	330KW	500KW
Rated voltage	Vca	320 V trifase (+/-15%)	
Rated current	Ica	600A	905
Max current	Ica	706A	1065
Rated frequency	Fca	50 Hz (+2 / -3 Hz)	
Distribution system		IT	
Harmonic distortion of the network current	THD%	< 3 % with rated power	
Power factor	cos ϕ	> 0.99 (adj. \pm 0.9)	
Contribution to short circuit current	Icc	900 A	1600 A
Standards			
Electromagnetic compatibility		YES	
CE conformity		YES	
Protection devices and environmental conditions			
IP protection degree EN60529		IP20	
Environmental categories		Indoor, unconditioned	
Overvoltage category (EN62109)		III (DC) – III (AC)	
Pollution degree		3	
Permitted temperature range	T	-20°C – 50°C ⁽¹⁾	
Maximum height above sea level		1000 m s.l.m. ⁽²⁾	
Air change (with $\Delta T=5^{\circ}C$)	m ³ / h	5240	7940
Direction of air flow		Intake through the base and the front Extraction from the top	
Max power dissipated	W KCal/h	6600 7725	10000 11700
Mechanical			
Weight	Kg	1000 Kg	1400 K
Dimensions	mm	1500x1000x1900	

N.B.

(1) with ambient temperature over 45°C there will be a reduction of max power to the grid

(2) over 1000m lower the power by 1% for every 100m up to a maximum of 3000m

SIRIO HHV MT		
Model		K800
Input		
Max PV power	Pmax	880KWp
Minimum recommended PV power	Pmin	500KWp
Recommended Vo@STC voltage	Vo	780-880 V
DC voltage range, MPPT	Vcc	530-820 V
Max DC voltage	Vcc,max	1000 V
Start-up voltage	Vstart-up	600 V
Max DC current	Icc,max	1600A
Voltage ripple on modules		< 1 %
DC inputs		1 (up to 20x160A fused opt.)
Output		
Rated AC power (p.f. = 1)	Pca	800KW
Rated voltage	Vca	320 V trifase (+/-15%)
Rated current	Ica	1450A
Max current	Ica	1600A
Rated frequency	Fca	50 Hz (+2 / -3 Hz)
Distribution system		IT
Harmonic distortion of the network current	THD%	< 3 % with rated power
Power factor	cos ϕ	> 0.99 (adj. \pm 0.9)
Contribution to short circuit current	Icc	2175A
Standards		
Electromagnetic compatibility		YES
CE conformity		YES
Protection devices and environmental conditions		
IP protection degree EN60529		IP20
Environmental categories		Indoor, unconditioned
Overvoltage category (EN62109)		III (DC) – III (AC)
Pollution degree		3
Permitted temperature range	T	-20°C – 50°C ⁽¹⁾
Maximum height above sea level		1000 m s.l.m. ⁽²⁾
Air change (with $\Delta T=5^{\circ}\text{C}$)	m ³ / h	12700
Direction of air flow		Intake through the base and the front Extraction from the top
Max power dissipated	W KCal/h	16000 18725
Mechanical		
Weight	Kg	1380 Kg + 200 Kg (DC box)
Dimensions	mm	1500x1000x1900 + 600x1000x1900 DC BOX

N.B.

(1) with ambient temperature over 45°C there will be a reduction of max power to the grid

(2) over 1000m lower the power by 1% for every 100m up to a maximum of 3000m

INVERTER USER PANEL FUNCTIONS.

General description.

The LCD Touch Screen control panel positioned on the front of the equipment can be used to monitor and control all parameters concerning the inverter, the distribution network and the photovoltaic modules. The following are the possible operating statuses:

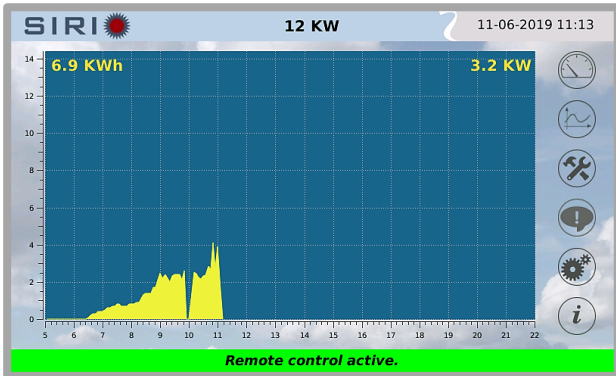

NORMAL OPERATION: This is the main screen and it shows the progress of the power generated and the energy produced during the current day. The background representing the daytime sky indicates the inverter is operating normally (grid-directed supply). After a period of inactivity, the screen switches to screen-saving mode and a "green" symbol is displayed that indicates everything is operating properly. Touch the display to return to the graphs.

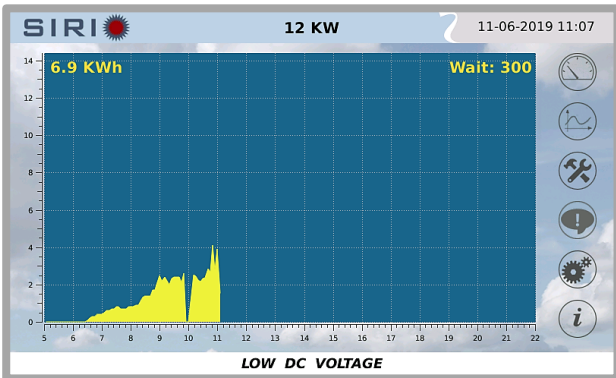

PAUSE: The status bar becomes "WHITE" indicates the inverter does not have sufficient DC voltage to begin supply to the grid. After a period of inactivity during the night hours (from 22:00 to 05:00), the screen automatically switches off. Touch it to switch on again.

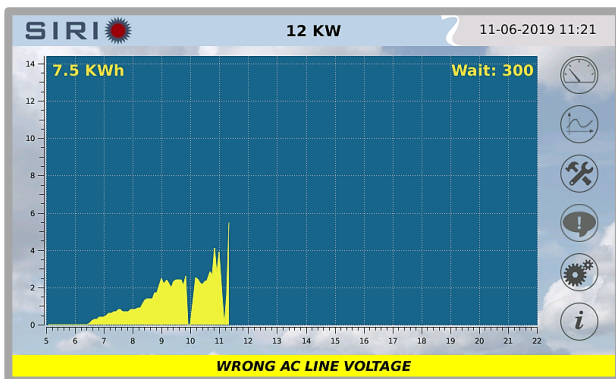

ALARM: The status bar becomes "YELOW" means that irradiation conditions are good, but the inverter does not start because of temporary problems such as the grid supply voltage is not suitable, inverter overtemperature, etc. At the bottom of the screen a series of messages scrolls which explain the type of alarm. See the next section for an explanation of the messages.

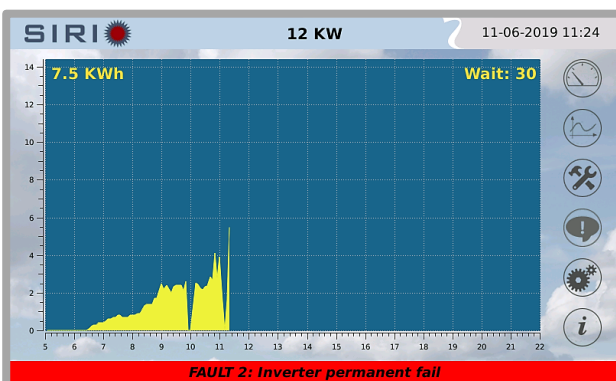

PERMANENT ALARM: The status bar becomes "RED" indicates that an alarm condition cannot be reset: to restore normal operation an intervention is necessary. In the lower part of the screen a series of messages scrolls which explain the alarm types. See the next section for an explanation of the messages.

Alarm messages

Below is a list of the alarm messages that are shown on the first line of the display panel.

<p>PAUSE, WAIT</p>	<p>The inverter is in a paused condition. If the condition that caused the pause is no longer active, a counter will be displayed to the right of this message indicating how many seconds are left before the restart of the inverter.</p>
<p>INTERFERENCE ON AC NETWORK</p>	<p>Alarm displayed when there is interference on the AC line, such as voltage peaks or harmonic distortion, while the voltage and frequency are correct. WARNING: in this case the inverter is not synchronized with the AC line and no connection can take place.</p>
<p>WRONG AC VOLTAGE</p>	<p>Alarm present if the voltage at the inverter AC input is not correct (in voltage, frequency or frequency derivative). Symbols indicating the problem are displayed to the right of this message: V: the voltage is outside the pre-defined limits F: the frequency is outside the pre-defined limits D: the frequency derivative is outside the pre-defined limit These three conditions may also occur simultaneously.</p>
<p>LOW DIRECT VOLTAGE</p>	<p>The voltage on the photovoltaic modules is lower than the start-up value (insufficient irradiation). If the irradiation conditions are good, check the status of any sectioning devices upstream of the inverter. This message could also indicate that the protection fuse inside the inverter has been triggered.</p>
<p>OVERLOAD</p>	<p>This indicates that the power supplied to the network is greater than the rated power of the inverter, thus the value indicated, expressed as a percentage, exceeds the value of 100% (up to a maximum of 110%). This condition is allowed temporarily for the time given in the technical data of the inverter. After this time the inverter enters a limiting condition in order to eliminate the possibility of an overload. If this condition lasts for long periods, check that the inverter has been sized correctly with respect to the power of the photovoltaic field.</p>
<p>LIMITATION DUE TO OVERLOAD</p>	<p>The overload in output ($P > 100\%$) has lasted longer than the cut-off time and thus the inverter has started to limit the power fed into the network to the rated value ($P_{max} = 100\%$). The limitation state lasts for a time that varies according to the level of power injected into the network in the period following the limitation.</p>

INTERNAL FAULT: number	Contact the technical support service if this message is displayed. Refer to the technical support manual to decode the fault number.
OVERTEMPERATURE OR NO VENTILATION	Alarm that occurs when one of the internal temperatures on the system card, the inverter power modules or the output transformer, has exceeded the maximum value allowed. This may be caused by: - operation in an environment where the temperature is too high and/or ventilation is poor; - a fault in the fans.
WRONG INPUT PHASE SEQUENCE	Indicates that the sequence of phases at the AC line input is not correct. It is normally sufficient to switch the two phases over in order to obtain normal operation.
BLOCK COMMAND ACTIVE;	Alarm present when the total shutdown command, COMMAND SAVED , has been entered from the panel or through the RS232 connection. The system executes the shutdown command with a few seconds' delay to allow for cancellation. The command remains saved even during shutdown due to a power outage. When the power supply is restored, the system cannot resume normal operation if the block that has been intentionally set is not deactivated.
REMOTE BLOCKING COMMAND ACTIVE 8=DEACTIV.	As the previous alarm, with command present from the "REMOTE" connector.
BLOCK COMMAND ACTIVE; (EPO)	The inverter is blocked due to the action of the EPO circuit (emergency shutdown). To restart the inverter restore the "EPO jumper" circuit and press key 8 on the inverter keyboard.
MEMORY CHANGED: CODE = number	Code 1 the memory has been changed and the operating parameters have returned to standard values. If non-standard values were previously set, these must be personalized again. Remove the power supply to the inverter in order to remove the alarm from the display. N.B.: codes other than 1 may be displayed temporarily when changing the personalization, but this does not affect normal operation.
LOW PHOTOVOLTAIC FIELD ISOLATION	The inverter detects insufficient isolation of the PV field towards the ground. Perform an inspection of the photovoltaic system.

CONTROL PANEL

For detailed operation of the control panel (display) refer to the dedicated manual.



RPS SpA
via Somalia, 20
20032 Cormano (MI)
www.riello-solartech.it

11/2020

OMNPNV364K55ENUG